

Article number: 439500440
 Description: Rota-fix shaft-hub connection F440x535
 Steel
 Note: Self centering. Very high torque

Measures

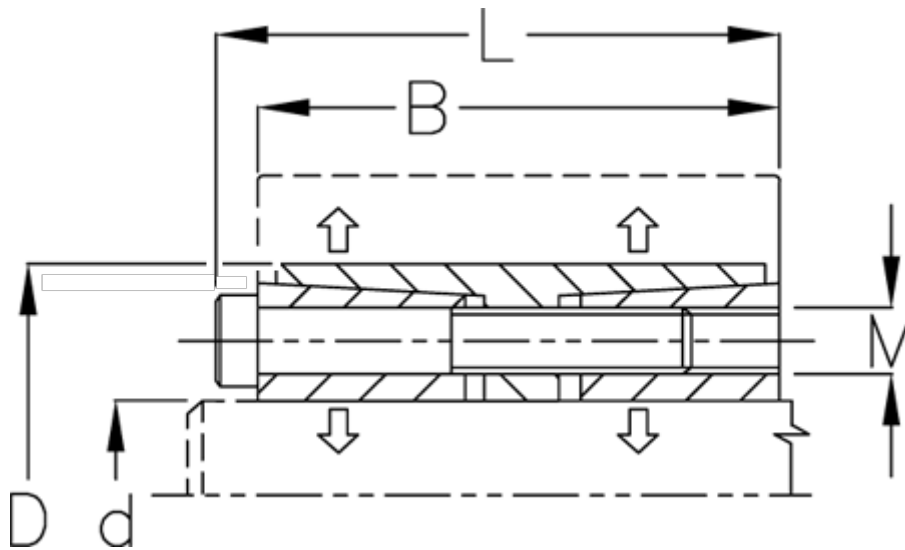

B mm	= 202
d H8 mm	= 440
D mm	= 535
Fit tolerance	= Aksel h8, Nav H8
F kN torque	= 3591.0
L mm	= 224
M mm	= M22
P N/mm ² surface pressure on shaft/hub	= 98

Surface roughness	= R? ? 3.2 μ m
T N m torque	= 790000
Ts N m bolt tightening torque	= 930.0